



FHP3350, FHP3450 Triple and Quad Voltage Feedback Amplifiers

Features

- 0.1dB gain flatness to 30MHz
- 0.07%/0.03° differential gain/phase error
- 210MHz full power -3dB bandwidth at G = 2
- 1,100V/μs slew rate
- ±55mA output current (drives dual video load)
- ±83mA output short-circuit current
- Output swings to within 1.3V of either rail
- 3.6mA supply current per amplifier
- Minimum stable gain of 3dB or 1.5V/V
- FHP3350 - improved replacement for RC6333
- FHP3450 - improved replacement for RC6334
- Fully specified at +5V, and ±5V supplies

Applications

- Video driver
- RGB driver
- ADC buffer
- S-video amp
- Active filters

Description

The FHP3350 and FHP3450 are low-cost, high-performance, voltage-feedback amplifiers designed for video applications. These triple and quad amplifiers consume only 3.6mA of supply current per channel and are capable of driving dual (75Ω) video loads while providing 0.1dB of gain flatness to 30MHz. Consumer video applications also benefit from the low 0.07% differential gain and 0.03° differential phase errors. The FHP3350 offers three outputs that can be put into a high-impedance disable state to allow for video multiplexing or minimize power consumption.

These amplifiers are designed to operate from 5V (±2.5V) to 12V (±6V) supplies. The outputs swing to within 1.3V of either supply rail to accommodate video signals on a single 5V supply.

The FHP3350 and FHP3450 are designed on a complementary bipolar process. They provide 210MHz of full-power bandwidth and 1,100V/μs of slew rate at a supply voltage of ±5V. The combination of high performance, low power, and excellent video performance make these amplifiers well suited for use in many digital consumer video appliances as well as many general-purpose, high-speed applications.

Typical Application – Driving Dual Video Loads

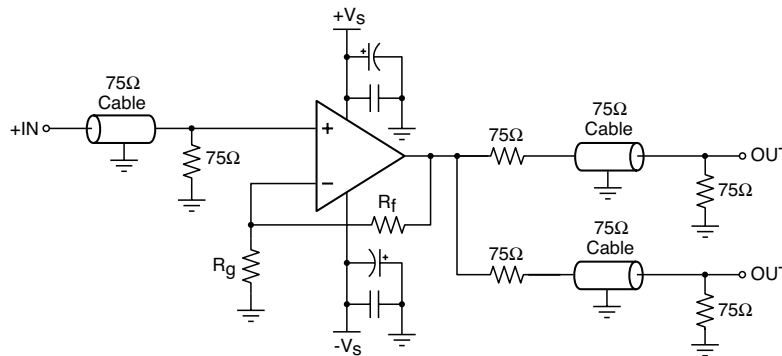

Ordering Information

| Part Number | Package | Lead Free | Operating Temp Range | Packaging Method |
|----------------|----------|-----------|----------------------|------------------|
| FHP3350IMTC14X | TSSOP-14 | Yes | -40°C to +85°C | Reel |
| FHP3350IM14X | SOIC-14 | Yes | -40°C to +85°C | Reel |
| FHP3450IMTC14X | TSSOP-14 | Yes | -40°C to +85°C | Reel |
| FHP3450IM14X | SOIC-14 | Yes | -40°C to +85°C | Reel |

Moisture sensitivity level for all parts is MSL-1.

FHP3350 Pin Configurations

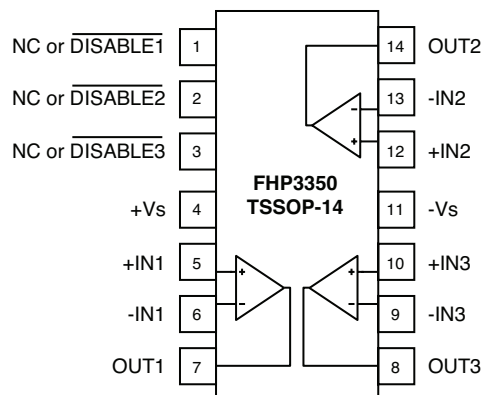

FHP3350 Pin Assignments

| Pin# | Pin | Description |
|------|----------------|--|
| 1 | NC or DISABLE1 | Channel 1 ENABLED if pin is left open or pulled above V_{ON} , DISABLED if pin is grounded or pulled below V_{OFF} |
| 2 | NC or DISABLE2 | Channel 2 ENABLED if pin is left open or pulled above V_{ON} , DISABLED if pin is grounded or pulled below V_{OFF} |
| 3 | NC or DISABLE3 | Channel 3 ENABLED if pin is left open or pulled above V_{ON} , DISABLED if pin is grounded or pulled below V_{OFF} |
| 4 | +Vs | Positive supply |
| 5 | +IN1 | Positive Input, channel 1 |
| 6 | -IN1 | Negative Input, channel 1 |
| 7 | OUT1 | Output, channel 1 |
| 8 | OUT3 | Output, channel 3 |
| 9 | -IN3 | Negative Input, channel 3 |
| 10 | +IN3 | Positive Input, channel 3 |
| 11 | -Vs | Negative supply |
| 12 | +IN2 | Positive Input, channel 2 |
| 13 | -IN2 | Negative Input, channel 2 |
| 14 | OUT2 | Output, channel 2 |

FHP3450 Pin Configurations

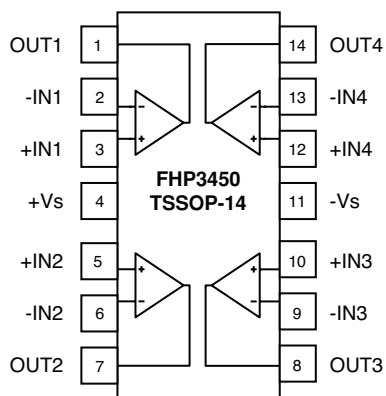

FHP3450 Pin Assignments

| Pin# | Pin | Description |
|------|------|---------------------------|
| 1 | OUT1 | Output, channel 1 |
| 2 | -IN1 | Negative Input, channel 1 |
| 3 | +IN1 | Positive Input, channel 1 |
| 4 | +Vs | Positive supply |
| 5 | +IN2 | Positive Input, channel 2 |
| 6 | -IN2 | Negative Input, channel 2 |
| 7 | OUT2 | Output, channel 2 |
| 8 | OUT3 | Output, channel 3 |
| 9 | -IN3 | Negative Input, channel 3 |
| 10 | +IN3 | Positive Input, channel 3 |
| 11 | -Vs | Negative supply |
| 12 | +IN4 | Positive Input, channel 4 |
| 13 | -IN4 | Negative Input, channel 4 |
| 14 | OUT4 | Output, channel 4 |

Absolute Maximum Ratings

The “Absolute Maximum Ratings” are those values beyond which the safety of the device cannot be guaranteed. The device should not be operated at these limits. The parametric values defined in the Electrical Characteristics tables are not guaranteed at the absolute maximum ratings. The “Recommended Operating Conditions” table defines the conditions for actual device operation.

| Parameter | Min. | Max. | Unit |
|---------------------|---------------|---------------|------|
| Supply Voltage | 0 | 12.6 | V |
| Input Voltage Range | $-V_s - 0.5V$ | $+V_s + 0.5V$ | V |

Reliability Information

| Parameter | Min. | Typ. | Max. | Unit |
|-----------------------------------|------|------|------|------|
| Junction Temperature | | | 150 | °C |
| Storage Temperature Range | -65 | | 150 | °C |
| Lead Temperature (Soldering, 10s) | | | 300 | °C |
| 14-Lead TSSOP ¹ | | 160 | | °C/W |
| 14-Lead SOIC ¹ | | 148 | | °C/W |

Note:

- Package thermal resistance (θ_{JA}), JEDEC standard, multi-layer test boards, still air.
Assumed power is concentrated in one channel, θ_{JA} is lower if power is distributed in all channels.

ESD Protection

| ESD Protection | FHP3350 | | FHP3450 | |
|----------------------------|---------|-------|---------|-------|
| | SOIC | TSSOP | SOIC | TSSOP |
| Package | SOIC | TSSOP | SOIC | TSSOP |
| Human Body Model (HBM) | 2kV | 2kV | 2kV | 2kV |
| Charged Device Model (CDM) | 2kV | 2kV | 2kV | 1.5kV |
| Machine Model (MM) | 250V | 250V | TBD | TBD |

Recommended Operating Conditions

| Parameter | Min. | Typ. | Max. | Unit |
|-----------------------------|------|------|------|------|
| Operating Temperature Range | -40 | | +85 | °C |
| Supply Voltage Range | 3 | | 12 | V |

Electrical Characteristics at +5V

$T_A = 25^\circ\text{C}$, $V_S = 5\text{V}$, $R_f = 249\Omega$, $R_L = 150\Omega$ to $V_S/2$, $G = 2$; unless otherwise noted.

| Symbol | Parameter | Conditions | Min. | Typ. | Max. | Units |
|----------------------------------|------------------------------------|---|--------------|----------|--------------|---------------------|
| Frequency Domain Response | | | | | | |
| BW_{ss} | -3dB Bandwidth | No Peaking, $G = +2$, $V_{OUT} = 0.2V_{pp}$ | | 190 | | MHz |
| BW_{Ls} | Full-Power Bandwidth | No Peaking, $G = +2$, $V_{OUT} = 2V_{pp}$ | | 190 | | MHz |
| $BW_{0.1dB}$ | 0.1dB Gain Flatness - Large Signal | $G = +2$, $V_{OUT} = 2V_{pp}$ | | 35 | | MHz |
| Time Domain Response | | | | | | |
| t_R, t_F | Rise and Fall Time | $V_{OUT} = 0.2V$ step | | 2.0 | | ns |
| t_S | Settling Time to 0.1% | $V_{OUT} = 2V$ step | | 20 | | ns |
| OS | Overshoot | $V_{OUT} = 0.2V$ step | | 2.5 | | % |
| SR | Slew Rate | 2V step. $G = -1$ | | 800 | | V/ μ s |
| Distortion/Noise Response | | | | | | |
| HD2 | 2nd Harmonic Distortion | $V_{OUT} = 2V_{pp}$, 5MHz | | -70 | | dBc |
| HD3 | 3rd Harmonic Distortion | $V_{OUT} = 2V_{pp}$, 5MHz | | -80 | | dBc |
| THD | Total Harmonic Distortion | $V_{OUT} = 2V_{pp}$, 5MHz | | -69 | | dB |
| DG | Differential Gain | NTSC (3.58MHz); AC coupled | | 0.08 | | % |
| DP | Differential Phase | NTSC (3.58MHz); AC coupled | | 0.02 | | $^\circ$ |
| e_n | Input Voltage Noise | > 100kHz | | 8.5 | | nV/Hz |
| i_n | Input Current Noise | > 100kHz | | 1 | | pA/Hz |
| X_{TALK} | Crosstalk | at 5MHz | | -70 | | dB |
| DC Performance | | | | | | |
| V_{IO} | Input Offset Voltage | | | 1 | | mV |
| dV_{IO} | Average Drift | | | 10 | | μ V/ $^\circ$ C |
| I_{bn} | Input Bias Current | | | ± 50 | | nA |
| dI_{bn} | Average Drift | | | 0.33 | | nA/ $^\circ$ C |
| I_{IO} | Input Offset Current | | | ± 50 | | nA |
| PSRR | Power Supply Rejection Ratio | DC | | 75 | | dB |
| A_{OL} | Open Loop Gain | DC | | 55 | | dB |
| I_S | Supply Current per Amplifier | | | 3.0 | | mA |
| I_{SD} | Disable Supply Current per Amp | Disable Mode | | 35 | | μ A |
| Disable Characteristics | | | | | | |
| OFF _{ISO} | Off Isolation | 5MHz | | -60 | | dB |
| OFFC _{OUT} | Off Output Capacitance | | | 3 | | pF |
| CH _{ISO} | Channel-to-Channel Isolation | 5MHz | | -85 | | dB |
| T_{ON} | Turn-On Time | | | 300 | | ns |
| T_{OFF} | Turn-Off Time | | | 80 | | ns |
| V_{OFF} | Power Down Input Voltage | DISABLE pins; disabled if pin is grounded or pulled below V_{OFF} | | | $+V_S - 3.1$ | V |
| V_{ON} | Enable Input Voltage | DISABLE pins; enabled if pin is left open or pulled above V_{ON} | $+V_S - 1.9$ | | | V |

Electrical Characteristics at +5V (Continued)

$T_A = 25^\circ\text{C}$, $V_S = 5\text{V}$, $R_f = 249\Omega$, $R_L = 150\Omega$ to $V_S/2$, $G = 2$; unless otherwise noted.

| Symbol | Parameter | Conditions | Min. | Typ. | Max. | Units |
|-------------------------------|---------------------------------|---|------|------------|------|-----------|
| Input Characteristics | | | | | | |
| R_{IN} | Input Resistance | | | 70 | | $M\Omega$ |
| C_{IN} | Input Capacitance | | | 1 | | pF |
| CMIR | Input Common Mode Voltage Range | | | 1.2 to 3.8 | | V |
| CMRR | Common Mode Rejection Ratio | DC, $V_{CM} = 1.5\text{V}$ to 3.5V | | 90 | | dB |
| Output Characteristics | | | | | | |
| V_O | Output Voltage Swing | $R_L = 2k\Omega$ to $V_S/2$ | | 1 to 4 | | V |
| | | $R_L = 150\Omega$ to $V_S/2$ | | 1.1 to 3.9 | | V |
| I_{OUT} | Linear Output Current | $V_O = +V_S/2$ | | ± 50 | | mA |
| I_{SC} | Short-Circuit Output Current | $V_O =$ shorted to $+V_S$ or GND | | ± 75 | | mA |

Electrical Characteristics at $\pm 5V$

$T_A = 25^\circ\text{C}$, $V_S = \pm 5V$, $R_f = 249\Omega$, $R_L = 150\Omega$ to GND, $G = 2$; unless otherwise noted.

| Symbol | Parameter | Conditions | Min. | Typ. | Max. | Units |
|------------------------------------|---|---|--------------|-----------|--------------|---------------------|
| Frequency Domain Response | | | | | | |
| BW_{ss} | -3dB Bandwidth | No Peaking, $G = +2$, $V_{OUT} = 0.2V_{pp}$ | | 210 | | MHz |
| BW_{Ls} | Full-Power Bandwidth | No Peaking, $G = +2$, $V_{OUT} = 2V_{pp}$ | | 210 | | MHz |
| $BW_{0.1dB}$ | 0.1dB Gain Flatness - Large Signal | $G = +2$, $V_{OUT} = 2V_{pp}$ | | 30 | | MHz |
| $BW_{0.1dBss}$ | 0.1dB Gain Flatness - Small Signal | $G = +2$, $V_{OUT} = 0.2V_{pp}$ | | 50 | | MHz |
| Time Domain Response | | | | | | |
| t_R, t_F | Rise and Fall Time | $V_{OUT} = 0.2V$ step | | 2 | | ns |
| t_S | Settling Time to 0.1% | $V_{OUT} = 2V$ step | | 20 | | ns |
| OS | Overshoot | $V_{OUT} = 0.2V$ step | | 1 | | % |
| SR | Slew Rate | 2V step. $G = -1$ | | 1100 | | V/ μ s |
| Distortion / Noise Response | | | | | | |
| HD2 | 2nd Harmonic Distortion | $V_{OUT} = 2V_{pp}$, 5MHz | | -70 | | dBc |
| HD3 | 3rd Harmonic Distortion | $V_{OUT} = 2V_{pp}$, 5MHz | | -74 | | dBc |
| THD | Total Harmonic Distortion | $V_{OUT} = 2V_{pp}$, 5MHz | | -68 | | dB |
| DG | Differential Gain | NTSC (3.58MHz); AC coupled | | 0.07 | | % |
| DP | Differential Phase | NTSC (3.58MHz); AC coupled | | 0.03 | | $^\circ$ |
| e_n | Input Voltage Noise | > 100kHz | | 9 | | nV/Hz |
| i_n | Input Current Noise | > 100kHz | | 1 | | pA/Hz |
| X_{TALK} | Crosstalk | at 5MHz | | -71 | | dB |
| DC Performance | | | | | | |
| V_{IO} | Input Offset Voltage ¹ | | -7 | 1 | 7 | mV |
| dV_{IO} | Average Drift | | | 15 | | μ V/ $^\circ$ C |
| I_{bn} | Input Bias Current ¹ | | -500 | ± 100 | 500 | nA |
| dI_{bn} | Average Drift | | | 0.3 | | nA/ $^\circ$ C |
| I_{IO} | Input Offset Current ¹ | | -500 | ± 50 | 500 | nA |
| PSRR | Power Supply Rejection Ratio ¹ | DC | 58 | 75 | | dB |
| A_{OL} | Open Loop Gain ¹ | DC | 52 | 58 | | dB |
| I_S | Supply Current per Amplifier ¹ | | | 3.6 | 5 | mA |
| I_{SD} | Disable Supply Current per Amp ¹ | Disable Mode | | 45 | 100 | μ A |
| Disable Characteristics | | | | | | |
| OFF_{ISO} | Off Isolation | 5MHz | | -65 | | dB |
| $OFFC_{OUT}$ | Off Output Capacitance | | | 3 | | pF |
| CH_{ISO} | Channel-to-Channel Isolation | 5MHz | | -85 | | dB |
| T_{ON} | Turn-On Time | | | 300 | | ns |
| T_{OFF} | Turn-Off Time | | | 80 | | ns |
| V_{OFF} | Power Down Input Voltage | DISABLE pins; disabled if pin is grounded or pulled below V_{OFF} | | | $+V_S - 3.1$ | V |
| V_{ON} | Enable Input Voltage | DISABLE pins; enabled if pin is left open or pulled above V_{ON} | $+V_S - 1.9$ | | | V |

Notes:

1. 100% tested at 25°C

Electrical Characteristics at $\pm 5V$ (Continued)

$T_A = 25^\circ\text{C}$, $V_S = \pm 5V$, $R_f = 249\Omega$, $R_L = 150\Omega$ to GND, $G = 2$; unless otherwise noted.

| Symbol | Parameter | Conditions | Min | Typ | Max | Units |
|-------------------------------|--|--------------------------------|-----------|-------------|-----|-----------|
| Input Characteristics | | | | | | |
| R_{IN} | Input Resistance | | | 70 | | $M\Omega$ |
| C_{IN} | Input Capacitance | | | 0.6 | | pF |
| CMIR | Input Common Mode Voltage Range | | | -3.8 to 3.8 | | V |
| CMRR | Common Mode Rejection Ratio ¹ | DC, $V_{CM} = -3.5V$ to $3.5V$ | 58 | 98 | | dB |
| Output Characteristics | | | | | | |
| V_O | Output Voltage Swing | $R_L = 2k\Omega$ | | ± 4 | | V |
| | | $R_L = 150\Omega$ ¹ | ± 3.2 | ± 3.7 | | V |
| I_{OUT} | Linear Output Current | $V_O = 0V$ | | ± 55 | | mA |
| I_{SC} | Short-Circuit Output Current | V_O shorted to GND | | ± 83 | | mA |

Notes:

1. 100% tested at 25°C

Typical Performance Characteristics

$T_A = 25^\circ\text{C}$, $V_S = 5\text{V}$, $R_f = 249\Omega$, $R_L = 150\Omega$ to $V_S/2$, $G = 2$; unless otherwise noted.

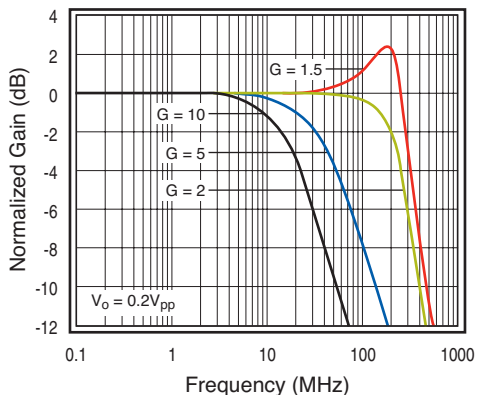

Figure 1. Non-Inverting Freq. Response ($\pm 5\text{V}$)

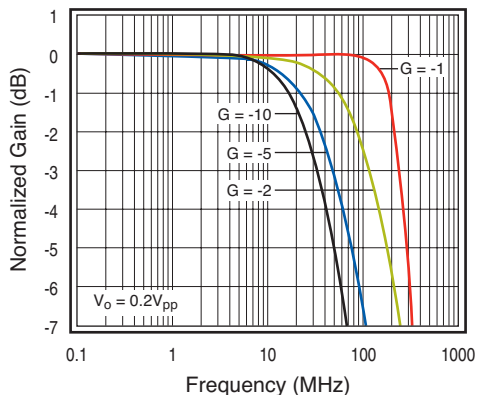

Figure 2. Inverting Freq. Response ($\pm 5\text{V}$)

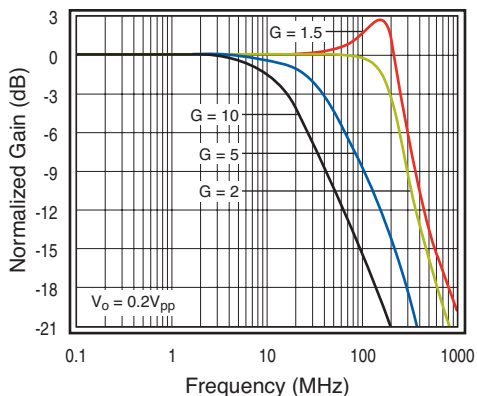

Figure 3. Non-Inverting Freq. Response (+5V)

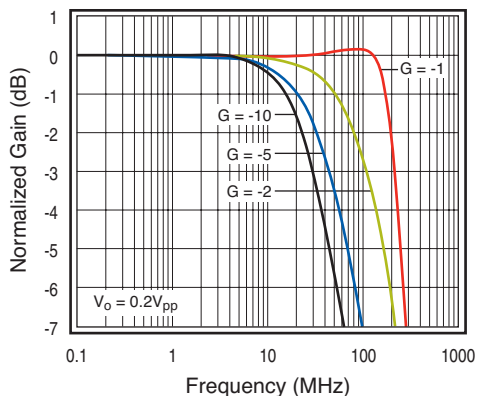

Figure 4. Inverting Freq. Response (+5V)

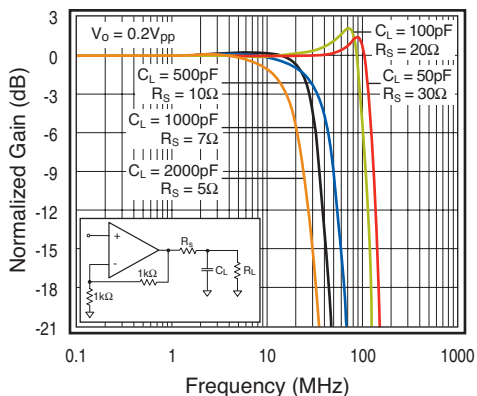

Figure 5. Frequency Response vs. C_L (+5V)

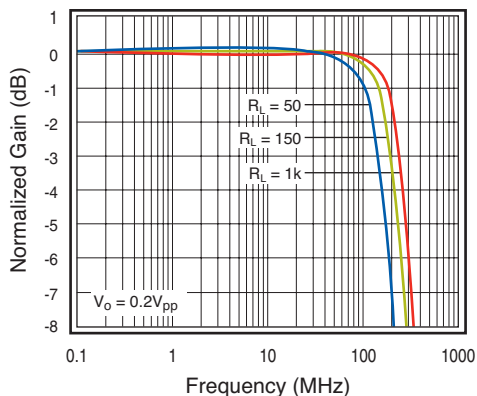

Figure 6. Frequency Response vs. R_L (+5V)

Typical Performance Characteristics

$T_A = 25^\circ\text{C}$, $V_S = 5\text{V}$, $R_f = 249\Omega$, $R_L = 150\Omega$ to $V_S/2$, $G = 2$; unless otherwise noted.

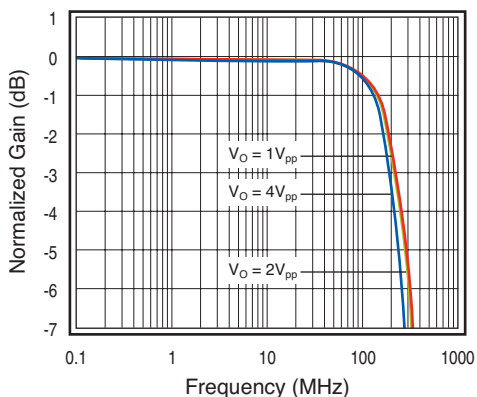

Figure 7. Large Signal Freq. Response ($\pm 5\text{V}$)

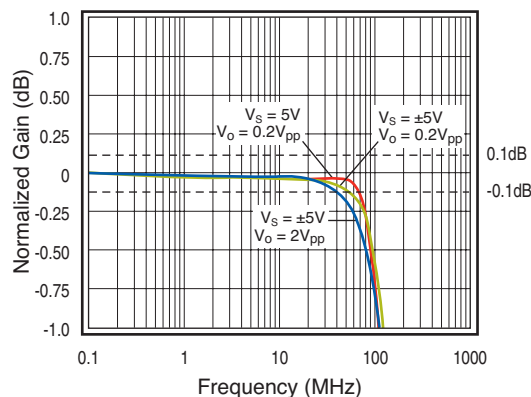

Figure 8. Gain Flatness vs. Frequency

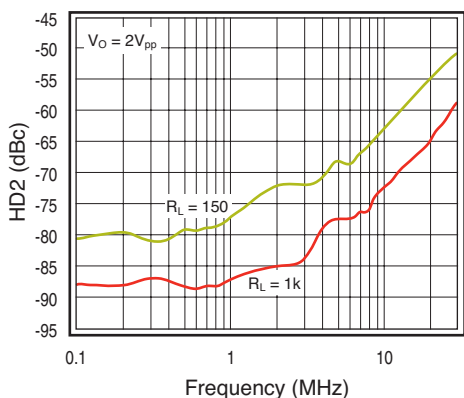

Figure 9. HD2 vs. Frequency ($\pm 5\text{V}$)

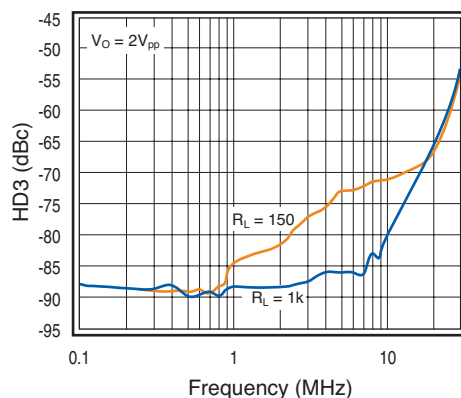

Figure 10. HD3 vs. Frequency ($\pm 5\text{V}$)

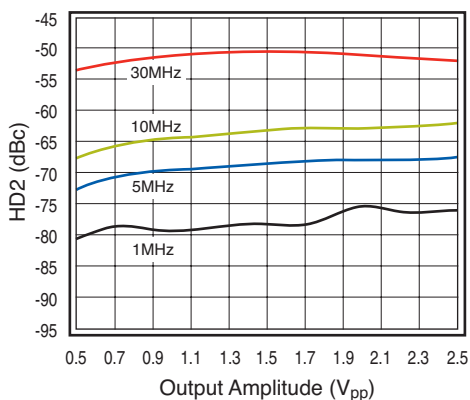

Figure 11. HD2 vs. V_O ($\pm 5\text{V}$)

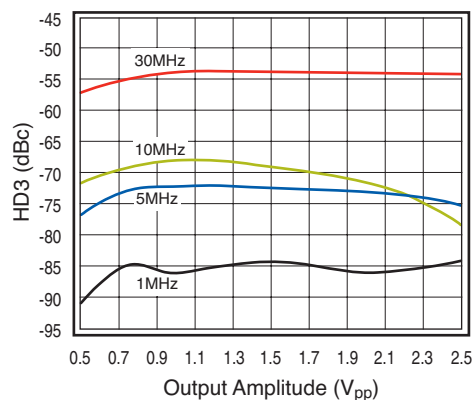

Figure 12. HD3 vs. V_O ($\pm 5\text{V}$)

Typical Performance Characteristics

$T_A = 25^\circ\text{C}$, $V_S = 5\text{V}$, $R_f = 249\Omega$, $R_L = 150\Omega$ to $V_S/2$, $G = 2$; unless otherwise noted.

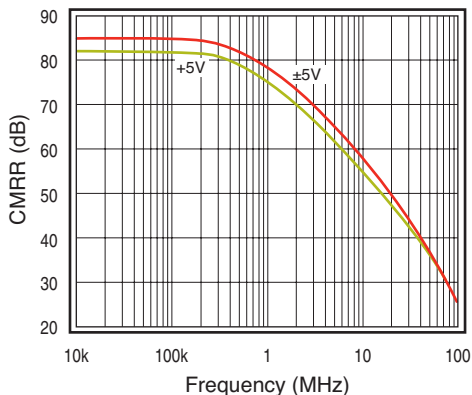

Figure 13. CMRR vs. Frequency

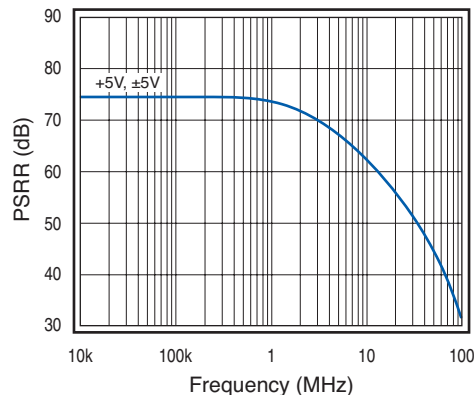

Figure 14. PSRR vs. Frequency

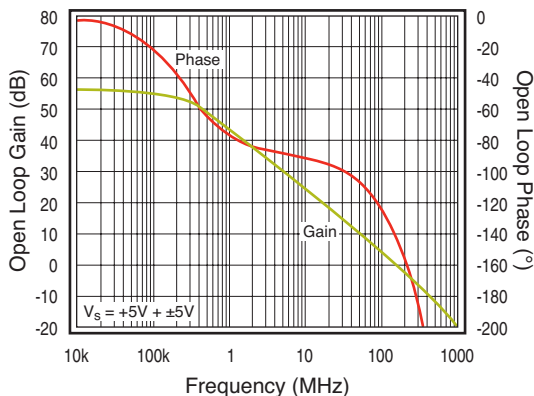

Figure 15. Open Loop Gain & Phase vs. Freq.

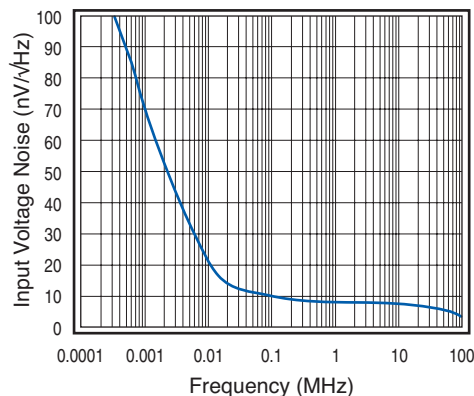

Figure 16. Input Voltage Noise (+5V)

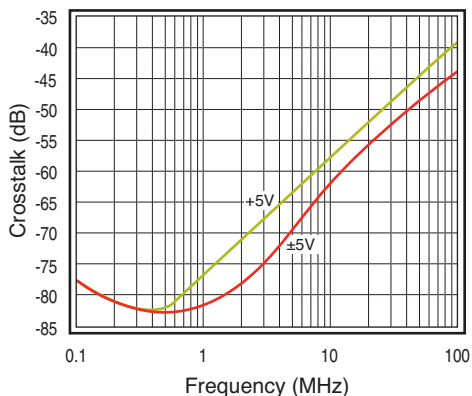

Figure 17. Crosstalk vs. Frequency (+5V)

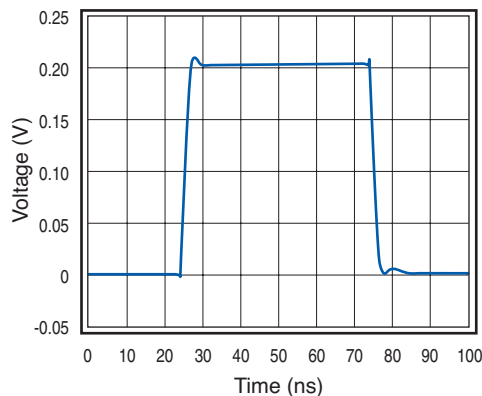

Figure 18. Small Signal Pulse Response (+5V)

Typical Performance Characteristics

$T_A = 25^\circ\text{C}$, $V_S = 5\text{V}$, $R_f = 249\Omega$, $R_L = 150\Omega$ to $V_S/2$, $G = 2$; unless otherwise noted.

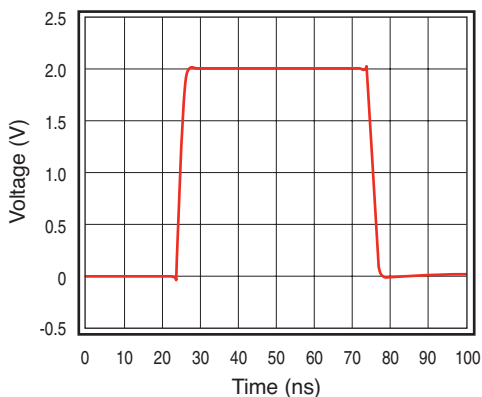

Figure 19. Large Signal Pulse Response (+5V)

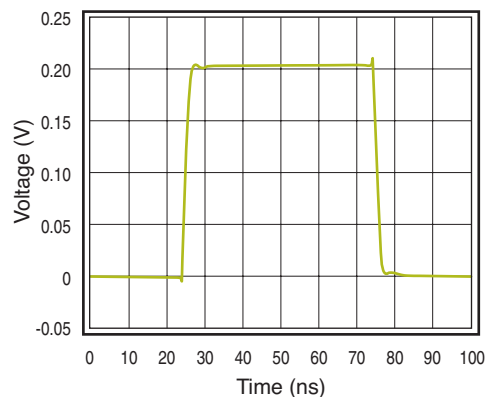

Figure 20. Small Signal Pulse Response ($\pm 5\text{V}$)

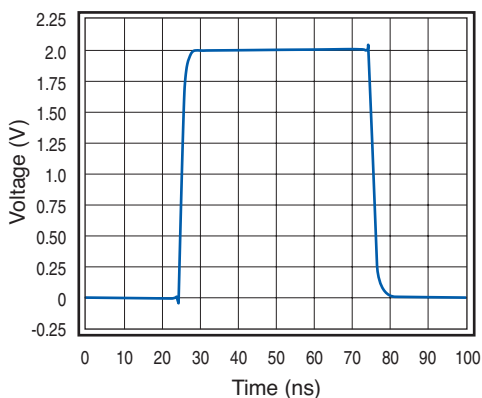

Figure 21. Large Signal Pulse Response ($\pm 5\text{V}$)

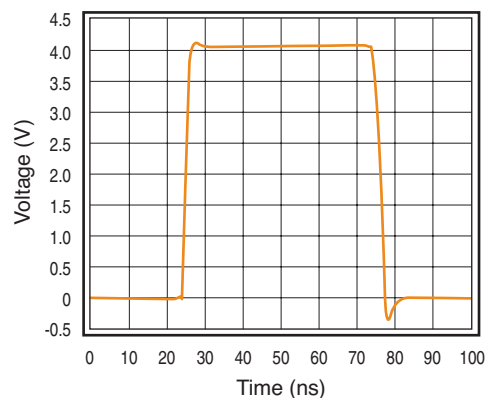

Figure 22. Large Signal Pulse Response ($\pm 5\text{V}$)

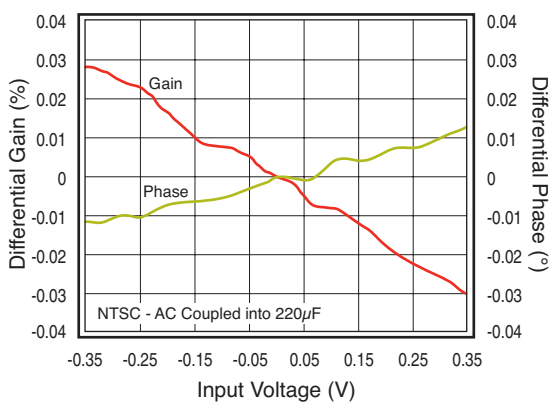

Figure 23. Differential Gain and Phase ($\pm 2.5\text{V}$)

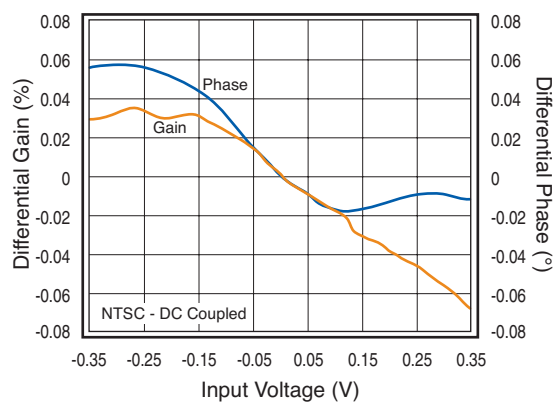

Figure 24. Differential Gain and Phase ($\pm 2.5\text{V}$)

Typical Performance Characteristics

$T_A = 25^\circ\text{C}$, $V_S = 5\text{V}$, $R_f = 249\Omega$, $R_L = 150\Omega$ to $V_S/2$, $G = 2$; unless otherwise noted.

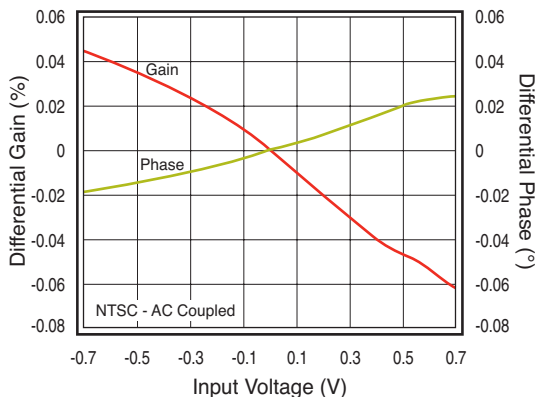

Figure 25. Differential Gain and Phase ($\pm 5\text{V}$)

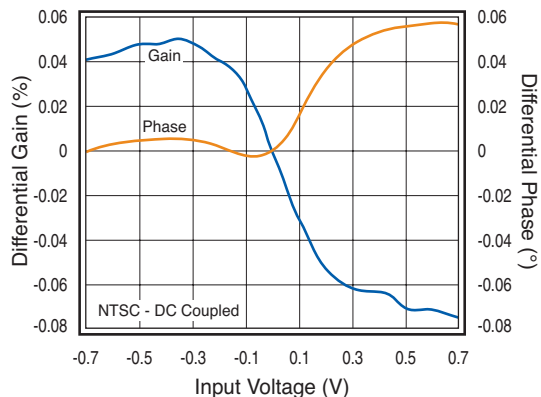

Figure 26. Differential Gain and Phase ($\pm 5\text{V}$)

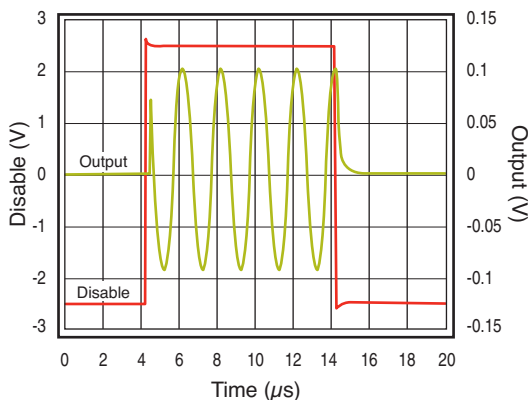

Figure 27. Enable/Disable Response ($\pm 2.5\text{V}$)

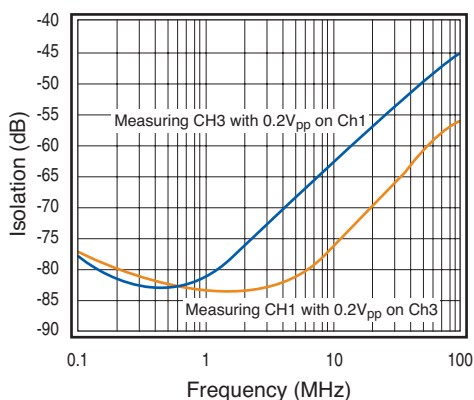

Figure 28. Channel-to-Channel Isolation ($+5\text{V}$)

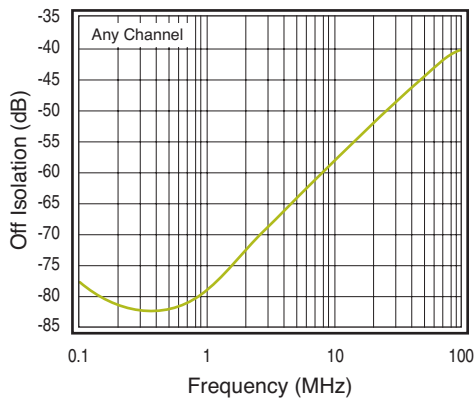

Figure 29. Off Isolation ($+5\text{V}$)

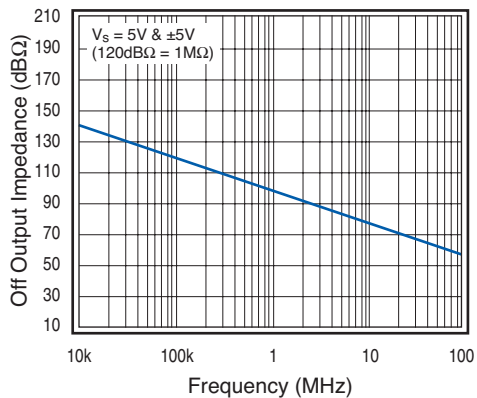

Figure 30. Off Output Impedance ($+5\text{V}$)

Applications Information

General Description

The FHP3350 and FHP3450 are low-cost, high-performance, voltage feedback amplifiers designed for video applications. These triple and quad amplifiers consume only 3.6mA of supply current per channel and are capable of driving dual (75Ω) video loads while providing 0.1dB of gain flatness to 30MHz. Consumer video applications also benefit from the low 0.07% differential gain and 0.03° differential phase errors. The FHP3350 offers three outputs that can be put into a high-impedance disable state to allow for video multiplexing or minimize power consumption.

These amplifiers are designed to operate from 5V (±2.5V) to 12V (±6V) supplies. The outputs swing to within 1.3V of either supply rail to accommodate video signals on a single 5V supply.

The FHP3350 and FHP3450 are designed on a complementary bipolar process. They provide 210MHz of full-power bandwidth and 1,100V/μs of slew rate at a supply voltage of ±5V. The combination of high performance, low power, and excellent video performance make these amplifiers well suited for use in many digital consumer video appliances as well as many general-purpose, high-speed applications.

Driving Capacitive Loads

The Frequency Response vs. C_L plot on page 8, illustrates the response of the FHP3350 Family. A small series resistance (R_s) at the output of the amplifier, illustrated in Figure 1, will improve stability and settling performance. R_s values in the Frequency Response vs. C_L plot were chosen to achieve maximum bandwidth with less than 1dB of peaking. For maximum flatness, use a larger R_s .

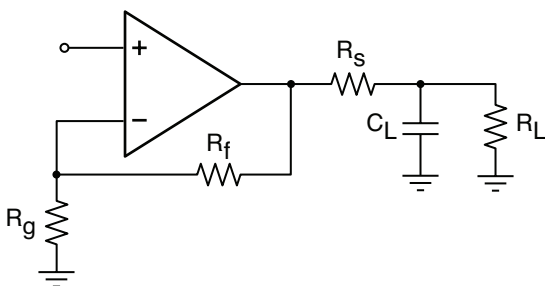

Figure 31. Typical Topology for Driving Capacitive Loads

Power Dissipation

The maximum internal power dissipation allowed is directly related to the maximum junction temperature. If the maximum junction temperature exceeds 150°C for an extended time, device failure may occur. The FHP3350 and FHP3450 are short circuit protected. However, this may not guarantee that the maximum junction temperature (+150°C) is not exceeded under all conditions. RMS Power Dissipation can be calculated using the following equation:

$$\text{Power Dissipation} = I_s * (V_s+ - V_s-) + (V_s+ - V_{o(RMS)}) * I_{OUT(RMS)}$$

Where I_s is the supply current, V_s+ is the positive supply pin voltage, V_s- is the negative supply pin voltage, $V_{o(RMS)}$ is the RMS output voltage and $I_{OUT(RMS)}$ is the RMS output current delivered to the load. Follow the maximum power derating curves shown in Figure 32 below to ensure proper operation.

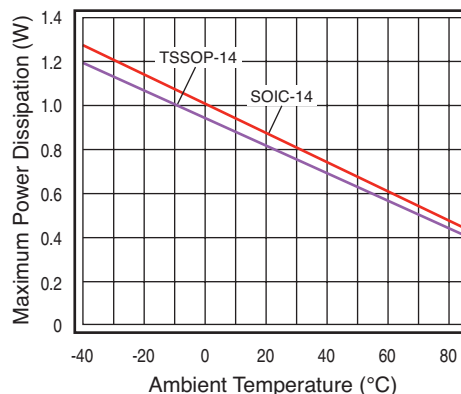

Figure 32. Maximum Power Derating

Overdrive Recovery

For an amplifier, an overdrive condition occurs when the output and/or input ranges are exceeded. The recovery time varies based on whether the input or output is overdriven and by how much the ranges are exceeded. The FHP3350/3450 will typically recover in less than 50ns from an overdrive condition. Figure 33 shows the FHP3350 in an overdriven condition.

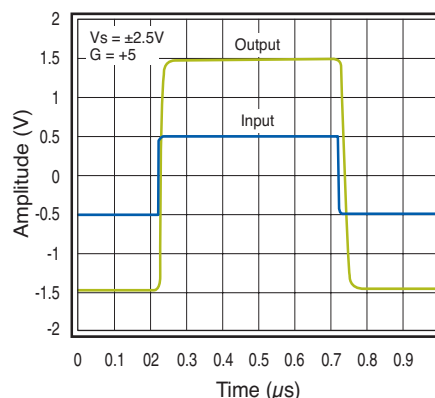

Figure 33. Overdrive Recovery

Layout Considerations

General layout and supply bypassing play major roles in high frequency performance. Fairchild has evaluation boards to use as a guide for high frequency layout and as aid in device testing and characterization. Follow the steps below as a basis for high frequency layout:

- Include 6.8 μ F and 0.01 μ F ceramic capacitors
- Place the 6.8 μ F capacitor within 0.75 inches of the power pin
- Place the 0.01 μ F capacitor within 0.1 inches of the power pin
- Remove the ground plane under and around the part, especially near the input and output pins to reduce parasitic capacitance
- Minimize all trace lengths to reduce series inductances

Refer to the evaluation board layouts below for more information.

Evaluation Board Information

The following evaluation boards are available to aid in the testing and layout of these devices:

| Evaluation Board # | Products |
|--------------------|----------------|
| KEB019 | FHP3350IM14X |
| KEB020 | FHP3350IMTC14X |
| KEB012 | FHP3450IMTC14X |
| KEB018 | FHP3450IM14X |

Evaluation Board Schematics

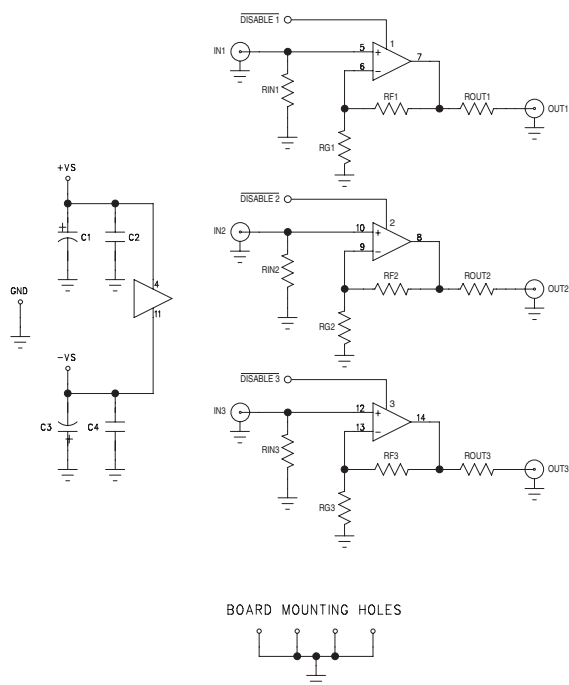

Figure 34. FHP3350 KEB019/KEB020 Schematic

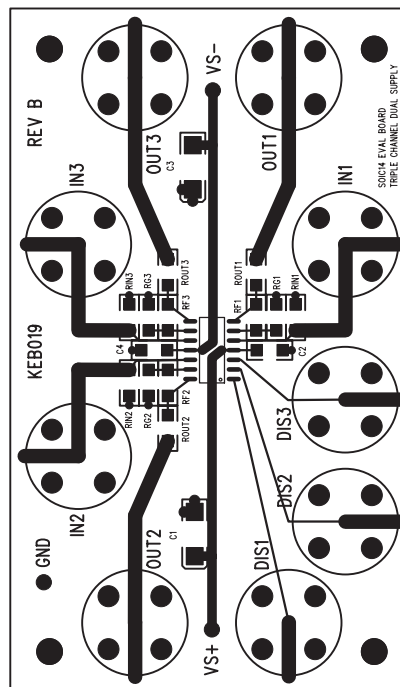

Figure 35. FHP3350 KEB019 (Top Side)

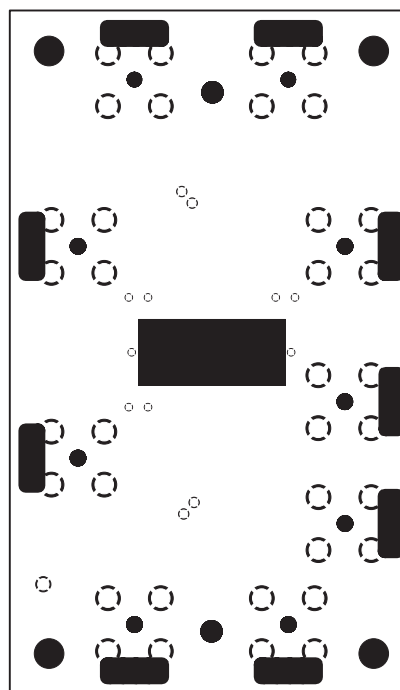

Figure 36. FHP3350 KEB019 (Bottom Side)

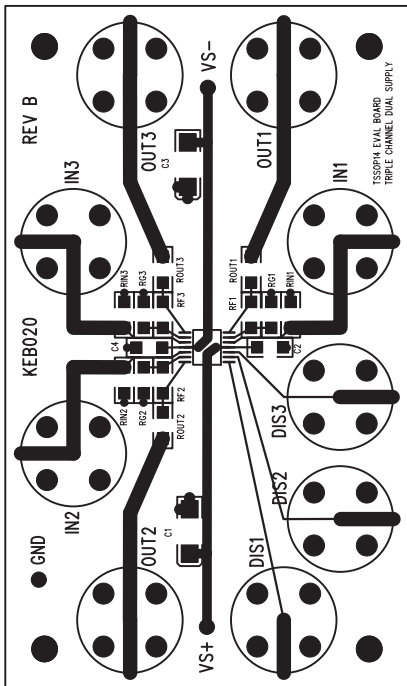

Figure 37. FHP3350 KEB020 (Top Side)

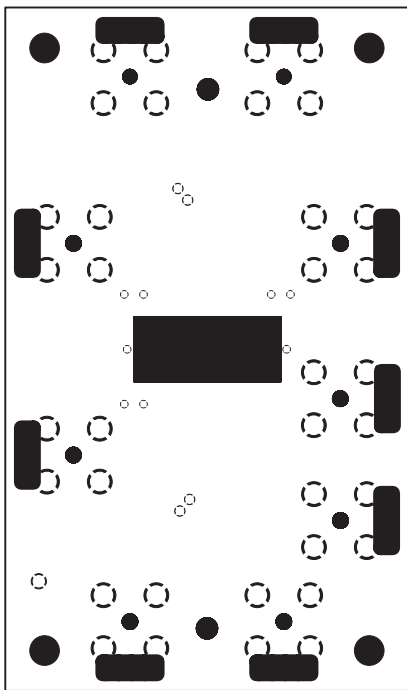

Figure 38. FHP3350 KEB020 (Bottom Side)

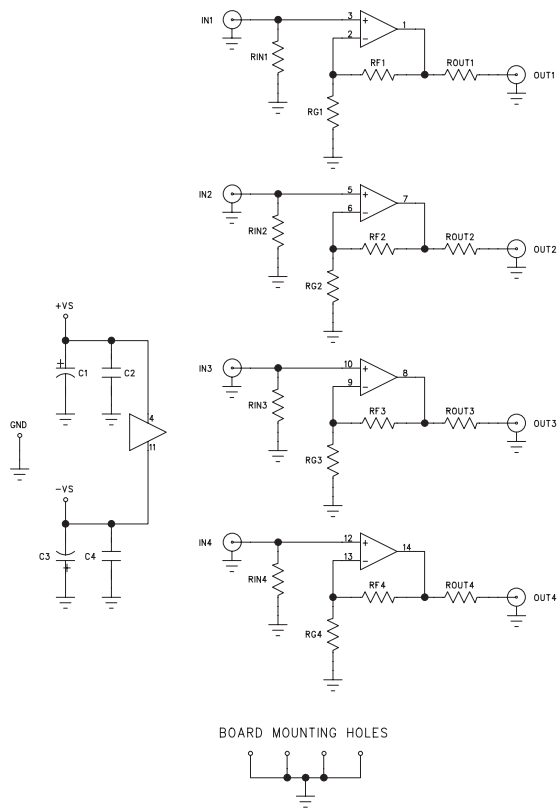

Figure 39. FHP3450 KEB012/KEB018 Schematic

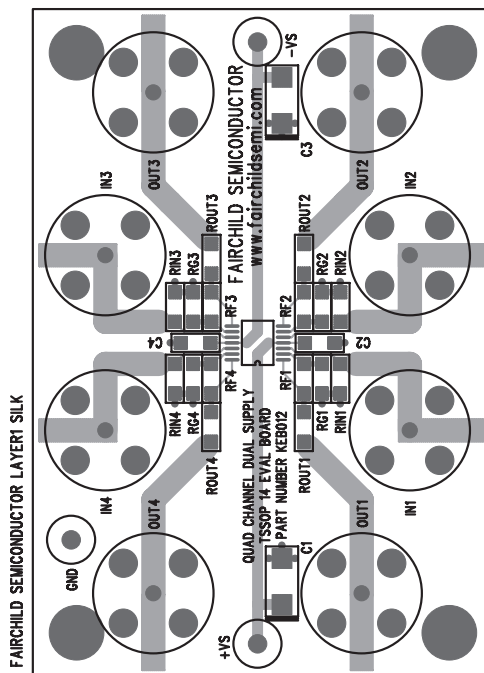

Figure 40. FHP3450 KEB012 (Top Side)

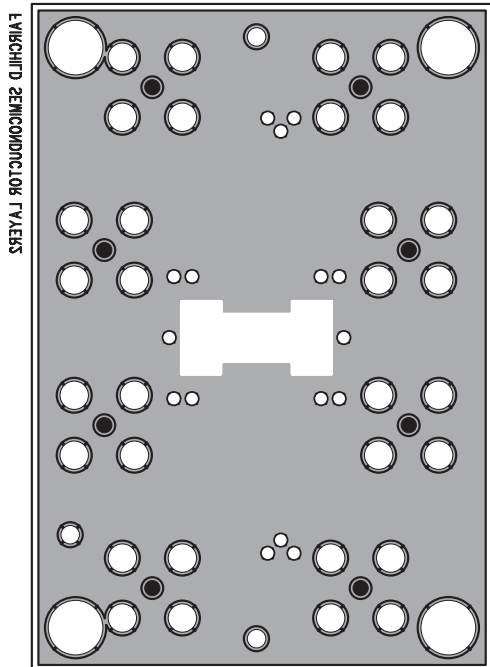

Figure 41. FHP3450 KEB012 (Bottom Side)

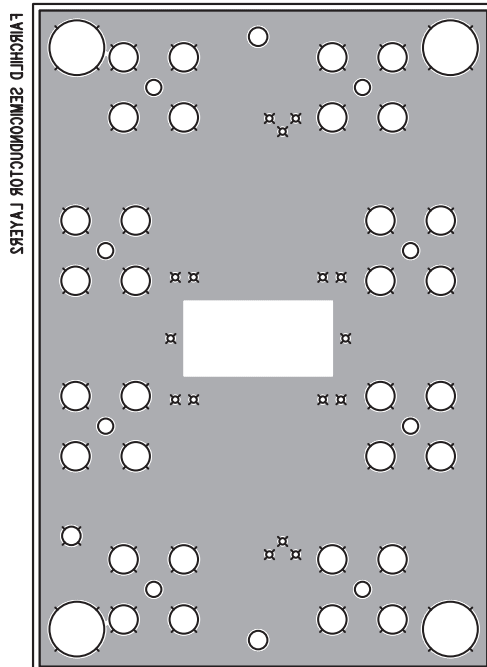

Figure 43. FHP3450 KEB018 (Bottom Side)

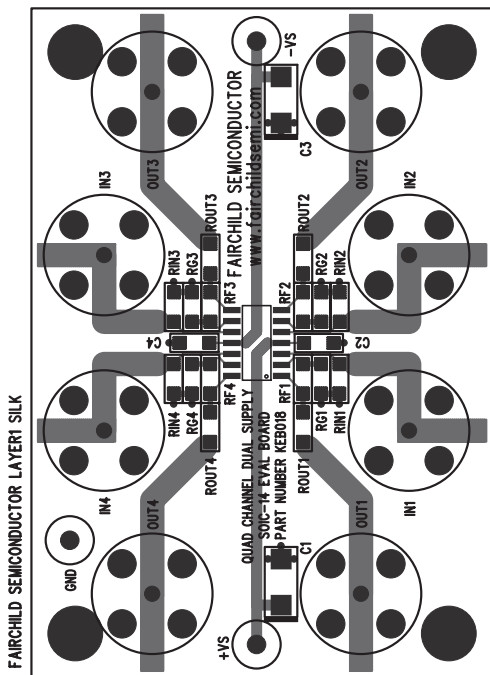
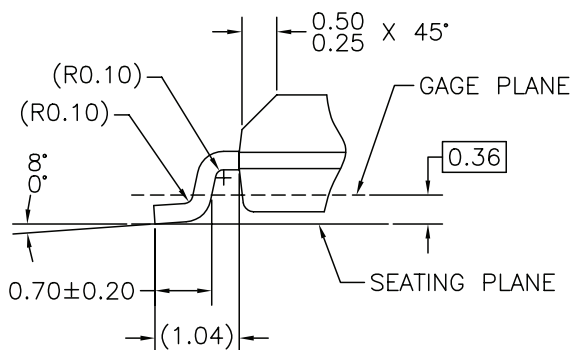
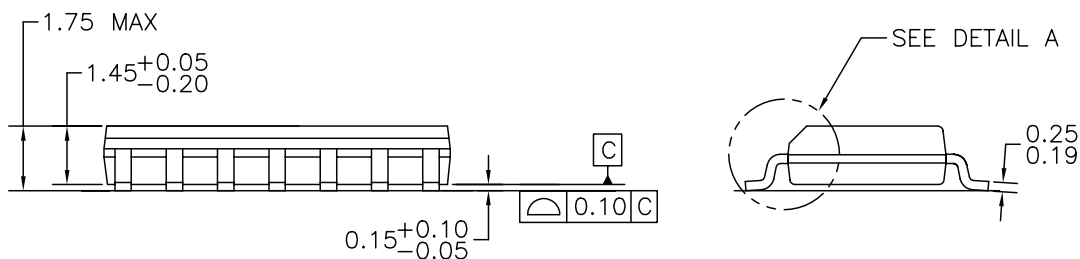
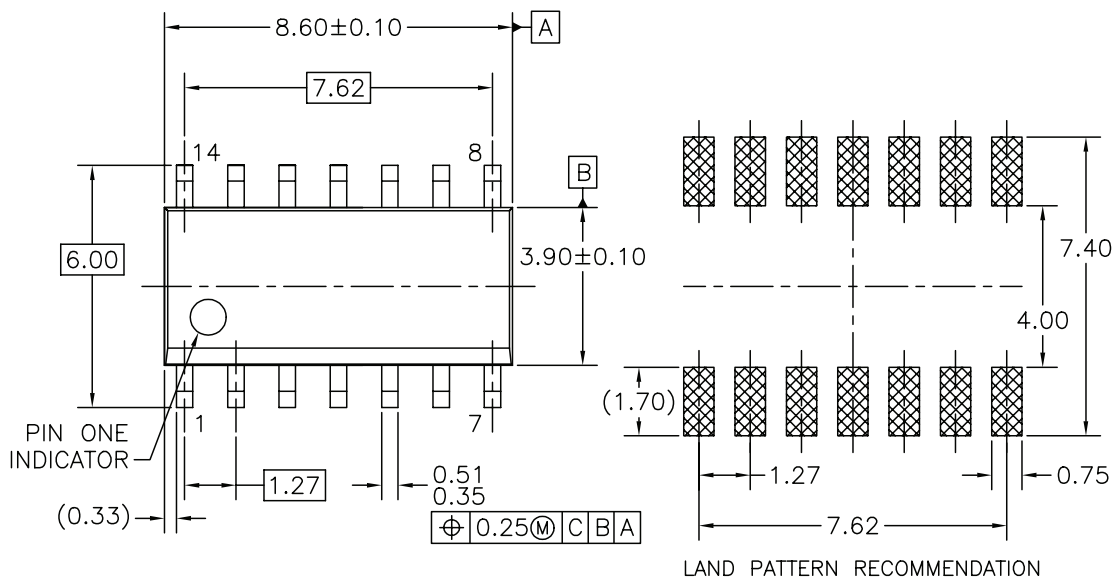

Figure 42. FHP3450 KEB018 (Top Side)

Mechanical Dimensions

14-Lead Small Outline Package (SOIC)
Number M14A RevL



NOTES: UNLESS OTHERWISE SPECIFIED

- A) THIS PACKAGE CONFORMS TO JEDEC MS-012, VARIATION AB, ISSUE C, DATED MAY 1990.
- B) ALL DIMENSIONS ARE IN MILLIMETERS.
- C) DIMENSIONS DO NOT INCLUDE MOLD FLASH OR BURRS.

M14AREVL

DETAIL A
SCALE: 20:1

TRADEMARKS

The following are registered and unregistered trademarks Fairchild Semiconductor owns or is authorized to use and is not intended to be an exhaustive list of all such trademarks.

| | | | | |
|--------------------------------------|---------------------|---------------------|------------------|---------|
| ACEx™ | FACT Quiet Series™ | OCX™ | SILENT SWITCHER® | UniFET™ |
| ActiveArray™ | GlobalOptoisolator™ | OCXPro™ | SMART START™ | VCX™ |
| Bottomless™ | GTO™ | OPTOLOGIC® | SPM™ | Wire™ |
| Build it Now™ | HiSeC™ | OPTOPLANAR™ | Stealth™ | |
| CoolFET™ | I ² C™ | PACMAN™ | SuperFET™ | |
| CROSSVOLT™ | i-Lo™ | POP™ | SuperSOT™-3 | |
| DOME™ | ImpliedDisconnect™ | Power247™ | SuperSOT™-6 | |
| EcoSPARK™ | IntelliMAX™ | PowerEdge™ | SuperSOT™-8 | |
| E ² C MOS™ | ISOPLANAR™ | PowerSaver™ | SyncFET™ | |
| EnSigna™ | LittleFET™ | PowerTrench® | TCM™ | |
| FACT® | MICROCOUPLER™ | QFET® | TinyBoost™ | |
| FAST® | MicroFET™ | QS™ | TinyBuck™ | |
| FASTr™ | MicroPak™ | QT Optoelectronics™ | TinyPWM™ | |
| FPS™ | MICROWIRE™ | Quiet Series™ | TinyPower™ | |
| FRFET™ | MSX™ | RapidConfigure™ | TinyLogic® | |
| | MSXPro™ | RapidConnect™ | TINYOPTO™ | |
| Across the board. Around the world.™ | | µSerDes™ | TruTranslation™ | |
| The Power Franchise® | | ScalarPump™ | UHC® | |
| Programmable Active Droop™ | | | | |

DISCLAIMER

FAIRCHILD SEMICONDUCTOR RESERVES THE RIGHT TO MAKE CHANGES WITHOUT FURTHER NOTICE TO ANY PRODUCTS HEREIN TO IMPROVE RELIABILITY, FUNCTION, OR DESIGN. FAIRCHILD DOES NOT ASSUME ANY LIABILITY ARISING OUT OF THE APPLICATION OR USE OF ANY PRODUCT OR CIRCUIT DESCRIBED HEREIN; NEITHER DOES IT CONVEY ANY LICENSE UNDER ITS PATENT RIGHTS, NOR THE RIGHTS OF OTHERS. THESE SPECIFICATIONS DO NOT EXPAND THE TERMS OF FAIRCHILD'S WORLDWIDE TERMS AND CONDITIONS, SPECIFICALLY THE WARRANTY THEREIN, WHICH COVERS THESE PRODUCTS.

LIFE SUPPORT POLICY

FAIRCHILD'S PRODUCTS ARE NOT AUTHORIZED FOR USE AS CRITICAL COMPONENTS IN LIFE SUPPORT DEVICES OR SYSTEMS WITHOUT THE EXPRESS WRITTEN APPROVAL OF FAIRCHILD SEMICONDUCTOR CORPORATION.

As used herein:

- Life support devices or systems are devices or systems which, (a) are intended for surgical implant into the body, or (b) support or sustain life, or (c) whose failure to perform when properly used in accordance with instructions for use provided in the labeling, can be reasonably expected to result in significant injury to the user.
- A critical component is any component of a life support device or system whose failure to perform can be reasonably expected to cause the failure of the life support device or system, or to affect its safety or effectiveness.

PRODUCT STATUS DEFINITIONS

Definition of Terms

| Datasheet Identification | Product Status | Definition |
|--------------------------|------------------------|--|
| Advance Information | Formative or In Design | This datasheet contains the design specifications for product development. Specifications may change in any manner without notice. |
| Preliminary | First Production | This datasheet contains preliminary data, and supplementary data will be published at a later date. Fairchild Semiconductor reserves the right to make changes at any time without notice to improve design. |
| No Identification Needed | Full Production | This datasheet contains final specifications. Fairchild Semiconductor reserves the right to make changes at any time without notice to improve design. |
| Obsolete | Not In Production | This datasheet contains specifications on a product that has been discontinued by Fairchild semiconductor. The datasheet is printed for reference information only. |

Rev. I22